



protium

SPECIALIZED IN LED LIGHTING



## Company Profile

---

Protium™ established in 2017, is a professional manufacturer engaged in the research, development, production, sale and service of Smart Switches, Smart Wifi Controllers, LED dimmer, LED controller, LED lights, LED strips light and Power supply. We are located in New Delhi.

Dedicated to strict quality control and thoughtful customer service, our experienced staff members are always available to discuss your requirements and ensure full customer satisfaction.

Protium™ Lighting Group is a leading supplier of customized lighting solutions for exhibits, retail environments along with commercial and residential applications.

We offer a full line of innovative LED products, theatrical and DMX lighting, and rechargeable battery powered lighting solutions. Our unique designs, comprehensive catalogue, and decades of technical expertise bring you on/off-site support during planning, design, fabrication and installation.



# ☰ contents

# CONTROLLERS

01	RF 2.4G Controller
04	Wi-Fi Controller
07	Bluetooth Controller
08	Touch Controller
09	Non Smart Controllers
11	DALI Control System
12	LED Dimmer
13	PIR Sensors / Dimmer Switches
15	PWM Amplifier
16	Pixel / Addressable Controller
19	Zigbee Controllers
20	Accessories (Connectors/Cables)
23	Power Supplies (5V)
24	Power Supplies (12V)
26	Dimmable Power Supplies (12V)

## RF Controllers 2.4Ghz



Model: PR-UT01 (DIM)  
Remote battery need: CR2032\*1pcs  
Remote Distance: 20-30 Meters (65-98ft)  
Controller supply Voltage: DC12-24V(CV)  
Output Current: 4A\*3CH(V-/V-/V-/V+) Function:  
(Slim case remote design) 1.Control Single  
Color Constant Voltage led lights.  
2. Dimming, Dynamic mode.  
3.zones design.



Model: PR-DST-01 (DIM)  
Remote battery need: AAA\*2pcs  
Remote Distance: 20-30 Meters (65-98ft)  
Controller supply Voltage: DC12-24V(CV)  
Output Current: 4A\*3CH(V-/V-/V-/V+)  
Function:  
1. Control Single Color Constant Voltage led  
lights.  
2. Dimming, Dynamic mode,  
3.zones design.



Model: PR-UT02 (CCT)  
Remote battery need: CR2032\*1pcs  
Remote Distance: 20-30 Meters (65-98ft)  
Controller supply Voltage: DC12-24V(CV)  
Output Current: 6A\*2CH(W-/C-/V+/V+)  
Function: (Slim case remote design)  
1. Control Warm+Cool white Constant  
Voltage led lights.  
2. Color Temperature Changing, Dimming,  
Dynamic mode.  
3.zones design.



Model: PR-DST-02 (CCT)  
Remote battery need: AAA\*2pcs  
Remote Distance: 20-30 Meters (65-98ft)  
Controller supply Voltage: DC12-24V(CV) Output  
Current: 6A\*2CH(W-/C-/V+/V+)  
Function:  
1. Control Warm+Cool white Constant Voltage  
led lights.  
2. Color Temperature Changing, Dimming,  
Dynamic mode.  
3.zones design.



Model: PR-UT03 (RGB)  
Remote battery need: CR2032\*1pcs  
Remote Distance: 20-30 Meters (65-98ft)  
Controller supply Voltage: DC12-24V(CV)  
Output Current: 4A\*3CH(R-/G-/B-/V+)  
Function: (Slim case remote design)  
1. Control RGB Constant Voltage led lights.  
2. Color Changing, Dimming, Dynamic  
modes, Mix white.  
3.zones design.



Model: PR-DST-03 (RGB)  
Remote battery need: AAA\*2pcs  
Remote Distance: 20-30 Meters (65-98ft)  
Controller supply Voltage: DC12-24V(CV)  
Output Current: 4A\*3CH(R-/G-/B-/V+)  
Function:  
1. Control RGB Constant Voltage led lights. 2. Color  
Changing, Dimming, Dynamic modes, Mix White.  
3 zones design.



Model: PR-UT04 (RGBW)  
Remote battery need: CR2032\*1pcs  
Remote Distance: 20-30 Meters (65-98ft)  
Controller supply Voltage: DC12-24V(CV)  
Output Current: 4A\*4CH(R-/G-/B-/W-/V+)  
Function: (Slim case remote design)  
1. Control RGBW Constant Voltage led lights.  
2. Color Changing, Dimming, Dynamic  
modes, Pure White.  
3.zones design.



Model: PR-DST-04 (RGBW)  
Remote battery need: AAA\*2pcs  
Remote Distance: 20-30 Meters (65-98ft)  
Controller supply Voltage: DC12-24V(CV)  
Output Current: 4A\*4CH(R-/G-/B-/W-/V+)  
Function:  
1. Control RGBW Constant Voltage led lights.  
2. Color Changing, Dimming, Dynamic modes,  
Pure White.  
3.zones design.



## RF Controllers 2.4Ghz



Model: PR- RFMB-01 (DIM)  
 Remote battery need: AAA\*2pcs  
 Remote Distance: 20-30 Meters (65-98ft)  
 Controller supply Voltage: DC12-24V(CV)  
 Output Current: 4A\*3CH(V-/V-/V-/V+)  
 Function: (touch panel remote design)  
 1.Control Single Color Constant Voltage led lights  
 2.Dimming, DIY, Delay off.  
 3.zones design.



Model: PR-T2.4G-01 (DIM)  
 Remote battery need: AAA \*2pcs  
 Remote Distance: 20-30 Meters (65-98ft)  
 Controller supply Voltage: DC12-24V(CV)  
 Output Current: 4A\*3CH(V-/V-/V-/V+)  
 Function:  
 1.Control Single Color Constant Voltage led lights.  
 2.Dimming, Dynamic mode.  
 3.zones design.



Model: PR- RFMB-02 (CCT)  
 Remote battery need: AAA\*2pcs  
 Remote Distance: 20-30 Meters (65-98ft)  
 Controller supply Voltage: DC12-24V(CV)  
 Output Current: 6A\*2CH(W-/C-/V+/V+)  
 Function: (touch panel remote design)  
 1.Control Warm+Cool white Constant Voltage led lights.  
 2.Color Temperature Changing, Dimming, DIY, Delay off.  
 3.zones design.



Model: PR-T2.4G-02 (CCT)  
 Remote battery need: AAA \*2pcs  
 Remote Distance: 20-30 Meters (65-98ft)  
 Controller supply Voltage: DC12-24V(CV)  
 Output Current: 6A\*2CH(W-/C-/V+/V+)  
 Function:  
 1.Control Warm+Cool white Constant Voltage led lights.  
 2.Color Temperature Changing, Dimming, Dynamic mode.  
 3.zones design.



Model: PR- RFMB-03 (RGB)  
 Remote battery need: AAA\*2pcs  
 Remote Distance: 20-30 Meters (65-98ft)  
 Controller supply Voltage: DC12-24V(CV)  
 Output Current: 4A\*3CH(R-/G-/B-/V+)  
 Function: (touch panel remote design)  
 1.Control RGB Constant Voltage led lights.  
 2.Color Changing, Dimming, Dynamic modes, Mix white,  
 3.zones design.



Model: PR-T2.4G-03 (RGB)  
 Remote battery need: AAA \*2pcs  
 Remote Distance: 20-30 Meters (65-98ft)  
 Controller supply Voltage: DC12-24V(CV)  
 Output Current: 6A\*3CH(R-/G-/B-/V+)  
 Function: (compatible with milight WiFi)  
 1.Control RGB Constant Voltage led lights.  
 2.Color Changing, Dimming, Dynamic modes, Mix white.  
 3.zones design.



Model: PR-RFMB-04 (RGBW)  
 Remote battery need: AAA\*2pcs  
 Remote Distance: 20-30 Meters (65-98ft)  
 Controller supply Voltage: DC12-24V(CV)  
 Output Current: 4A\*4CH(R-/G-/B-/W-/V+)  
 Function:(touch panel remote design)  
 1.Control RGBW Constant Voltage led lights.  
 2.Color Changing, Dimming, Dynamic modes, Pure White,  
 3.zones design.



Model: PR-T2.4G-04 (RGBW)  
 Remote battery need: AAA\*2pcs  
 Remote Distance: 20-30 Meters (65-98ft)  
 Controller supply Voltage: DC12-24V(CV)  
 Output Current: 6A\*4CH(R-/G-/B-/W-/V+)  
 Function: (compatible with milight WiFi)  
 1.Control RGBW Constant Voltage led lights.  
 2.Color Changing, Dimming, Dynamic modes, Pure White.  
 3.zones design.

## RF Controllers 2.4Ghz



Model: PR-LB2.4G-03 (RGB)  
 Remote battery need: AAA \*2pcs  
 Remote Distance: 20-30 Meters (65-98ft)  
 Controller supply Voltage: DC12-24V(CV)  
 Output Current: 6A\*3CH(R-/G-/B-/V+)  
 Function:  
 1.Control RGB Constant Voltage led lights.  
 2.Dimming, Dynamic mode.



Model: PR-2.4G-04 (RGB)  
 Remote battery need: AAA \*2pcs  
 Remote Distance: 20-30 Meters (65-98ft)  
 Controller supply Voltage: DC12-24V(CV)  
 Output Current: 6A\*3CH(R-/G-/B-/V+)  
 Function:  
 1.Control RGB Constant Voltage led lights.  
 2.Dimming, Dynamic mode.



Model: PR-LB2.4G-04 (RGBW)  
 Remote battery need: AAA \*2pcs  
 Remote Distance: 20-30 Meters (65-98ft)  
 Controller supply Voltage: DC12-24V(CV)  
 Output Current: 6A\*4CH(R-/G-/B-/W-/V+)  
 Function:  
 1.Control RGBW Constant Voltage led lights.  
 2.Dimming, Dynamic mode.



Model: PR-2.4G-05 (RGBW)  
 Remote battery need: AAA \*2pcs  
 Remote Distance: 20-30 Meters (65-98ft)  
 Controller supply Voltage: DC12-24V(CV)  
 Output Current: 6A\*4CH(R-/G-/B-/W-/V+)  
 Function:  
 1.Control RGBW Constant Voltage led lights.  
 2.Dimming, Dynamic mode.



Model: PR-DST-0502 (RGB+CCT)  
 Remote battery need: AAA \*2pcs  
 Remote Distance: 20-30 Meters (65-98ft)  
 Controller supply Voltage: DC12-24V(CV)  
 Output Current: 4A\*5CH(R-/G-/B-/W-/C-/V+)  
 Function:  
 1.Control RGB+WW+CW Constant Voltage led lights.  
 2.Dimming, Dynamic mode, 8 zones design.



Model: PR-QC19 (RGB)  
 Remote battery need: AAA \*2pcs  
 Remote Distance: 20-30 Meters (65-98ft)  
 Controller supply Voltage: DC12-24V(CV)  
 Output Current: 10A\*3CH(R-/G-/B-/V+)  
 Function:  
 1.Control RGB Constant Voltage led lights.  
 2.Dimming, Dynamic mode.



Model: PR-Z8-RGBWC (RGB+CCT)  
 Remote battery need: AAA \*2pcs  
 Remote Distance: 20-30 Meters (65-98ft)  
 Controller supply Voltage: DC12-24V(CV)  
 Output Current: 4A\*5CH(R-/G-/B-/W-/C-/V+)  
 Function:  
 1.Control RGB+WW+CW Constant Voltage led lights.  
 2.Dimming, Dynamic mode, 8 zones design.

# Wi-Fi Controllers (Magic Home)



Model: PR-WFXB-IR24 (RGB)  
 Remote: IR, iphone, android, echo, google home, ifttt  
 Controller supply voltage: DC12-24V(CV)  
 Output Current: 100W  
 Function: (WiFi)  
 1. Control RGB Constant Voltage led lights.  
 2. Color changing, Dimming, changing mode, time, music.



Model: PR-MW-S (DIM)  
 Remote: iphone, android, echo, google home, ifttt  
 Controller supply voltage: DC5-28V(CV)  
 Output Current: 96W  
 Function: (WiFi)  
 1. Control Single Color Constant voltage led lights  
 2. Dimming, changing mode, time, music.

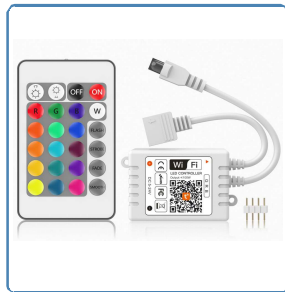

Model: PR-WIFI24-TY (RGB)  
 Remote: IR, iphone, android, echo, google home, ifttt  
 Controller supply voltage: DC12-24V(CV)  
 Output Current: 100W  
 Function: (WiFi)  
 1. Control RGB Constant Voltage led lights.  
 2. Color changing, Dimming, changing mode, time, music.



Model: PR-MW-RGB (RGB)  
 Remote: iphone, android, echo, google home, ifttt  
 Controller supply voltage: DC5-28V(CV)  
 Output Current: 100W  
 Function: (WiFi)  
 1. Control RGB Constant Voltage led lights.  
 2. Color changing, Dimming, changing mode, time, music.



Model: PR-WIRD-2MRGB (RGB)  
 Remote: IR, iphone, android, echo, google home, ifttt  
 Controller supply voltage: DC12-24V(CV)  
 Output Current: 144W  
 Function: (WiFi)  
 1. Control RGB Constant Voltage led lights.  
 2. Color changing, Dimming, changing mode, time, music.



Model: PR-MW-RGBW (RGBW)  
 Remote: iphone, android, echo, google home, ifttt  
 Controller supply voltage: DC5-28V(CV)  
 Output Current: 100W  
 Function: (WiFi)  
 1. Control RGBW Constant Voltage led lights.  
 2. Color changing, Dimming, changing mode, time, music.



Model: PR-WFXB-IR24-03 (RGB)  
 Remote: IR, iphone, android, echo, google home, ifttt  
 Controller supply voltage: DC12-24V(CV)  
 Output Current: 100W  
 Function: (WiFi)  
 1. Control RGB Constant Voltage led lights.  
 2. Color changing, Dimming, changing mode, time, music.



Model: PR-MW-RGBWW (RGBWC)  
 Remote: iphone, android, echo, google home, ifttt  
 Controller supply voltage: DC5-28V(CV)  
 Output Current: 100W  
 Function: (WiFi)  
 1. Control RGBWC Constant Voltage led lights.  
 2. Color changing, Dimming, changing mode, time, music.



# Wi-Fi Controllers (Magic Home)



Model: PR-MWIR-RGB (RGB)  
 Remote:IR,iphone,android,echo,google home,ifttt  
 Controller supply voltage: DC5-28V(CV)  
 Output Current: 100W  
 Function: (WiFi)  
 1.Control RGB Constant Voltage led lights.  
 2.Color changing, Dimming, changing mode, time,music.



Model: PR-MWRF-RGB (RGB)  
 Remote:RF,iphone,android,echo,google home,ifttt  
 Controller supply voltage: DC9-28V(CV)  
 Output Current: 100W  
 Function: (WiFi)  
 1.Control RGB Constant Voltage led lights.  
 2.Color changing, Dimming, changing mode,time,music.



Model: PR-MWIR-RGBW (RGBW)  
 Remote:IR,iphone,android,echo,google home,ifttt  
 Controller supply voltage: DC5-28V(CV)  
 Output Current: 100W  
 Function: (WiFi)  
 1.Control RGBW Constant Voltage led lights.  
 2.Color changing, Dimming, changing mode, time,music.



Model: PR-MWRF-RGBW (RGBW)  
 Remote:RF,iphone,android,echo,google home,ifttt  
 Controller supply voltage: DC9-28V(CV)  
 Output Current: 100W  
 Function: (WiFi)  
 1.Control RGBW Constant Voltage led lights.  
 2.Color changing, Dimming, changing mode, time,music.

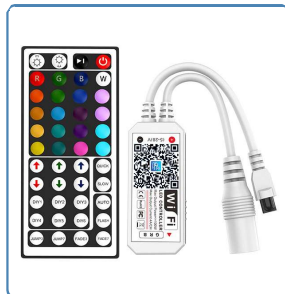

Model: PR-MWIR-RGB (RGB)  
 Remote:IR,iphone,android,echo,google home,ifttt  
 Controller supply voltage: DC5-28V(CV)  
 Output Current: 100W  
 Function: (WiFi)  
 1.Control RGB Constant Voltage led lights.  
 2.Color changing, Dimming, changing mode, time,music.



Model: PR-MWRF-RGBWW (RGBWC)  
 Remote:RF,iphone,android,echo,google home,ifttt  
 Controller supply voltage: DC9-28V(CV)  
 Output Current: 100W  
 Function: (WiFi)  
 1.Control RGBWC Constant Voltage led lights.  
 2.Color changing, Dimming, changing mode, time,music.



Model: PR-W-RGB (RGB)  
 Remote: iphone,android,echo,google home,ifttt  
 Controller supply voltage: DC12-24V(CV)  
 Output Current: 144W  
 Function: (WiFi) 5.0Ghz  
 1.Control RGB Constant Voltage led lights.  
 2.Color changing, Dimming, changing mode,time,music.



Model: PR-W-RGBWW (General Edition)  
 Remote: iphone,android,echo,google home,ifttt  
 Controller supply voltage: DC12-24V(CV)  
 Output Current: 240W  
 Function: (WiFi)  
 1.Control Single Color/Warm+cool white/ RGB/RGBW/RGBWC Constant Voltage led lights.  
 2.Color changing, Dimming, changing mode, time,music.





## Wi-Fi Controllers (Smart life)



Model: PR-SLNR-RGB (RGB)  
 Remote:IR,iphone,android,echo,google home,ifttt  
 Controller supply voltage: DC5-28V(CV)  
 Output Current: 100W  
 Function: (WiFi)  
 1.Control RGB Constant Voltage led lights.  
 2.Color changing, Dimming, changing mode, timer.



Model: PR-SLIR-RGB (RGB)  
 Remote:RF,iphone,android,echo,google home,ifttt  
 Controller supply voltage: DC9-28V(CV)  
 Output Current: 100W  
 Function: (WiFi)  
 1.Control RGB Constant Voltage led lights.  
 2.Color changing, Dimming, changing mode,time,music.



Model: PR-SLNR-RGBW (RGBW)  
 Remote:IR,iphone,android,echo,google home,ifttt  
 Controller supply voltage: DC5-28V(CV)  
 Output Current: 100W  
 Function: (WiFi)  
 1.Control RGBW Constant Voltage led lights.  
 2.Color changing, Dimming, changing mode, timer.



Model: PR-SL40-RGB (RGB), **Single Out**  
 Remote:RF,iphone,android,echo,google home,ifttt  
 Controller supply voltage: DC9-28V(CV)  
 Output Current: 100W  
 Function: (WiFi+BLE)  
 1.Control RGB Constant Voltage led lights.  
 2.Color changing, Dimming, changing mode, time,music.



Model: PR-SLRF-RGBW (RGBW)  
 Remote:RF,iphone,android,echo,google home,ifttt  
 Controller supply voltage: DC9-28V(CV)  
 Output Current: 100W  
 Function: (WiFi)  
 1.Control RGBWC Constant Voltage led lights.  
 2.Color changing, Dimming, changing mode, time,music.



Model: PR-SL40-RGB (RGB), **Dual Out**  
 Remote:RF,iphone,android,echo,google home,ifttt  
 Controller supply voltage: DC9-28V(CV)  
 Output Current: 100W  
 Function: (WiFi+BLE)  
 1.Control RGB Constant Voltage led lights.  
 2.Color changing, Dimming, changing mode, time,music.



Model: PR-SL24-RGBCW (RGB+CCT)  
 Remote:IR,iphone,android,echo,google home,ifttt  
 Controller supply voltage: DC9-28V(CV)  
 Output Current: 144W  
 Function: (WiFi)  
 1.Control RGB Constant Voltage led lights.  
 2.Color changing, Dimming, changing mode, time,music.



# Bluetooth Controllers



Model: PR-MB-RGBW (RGB/RGBW)  
 Remote distance: 10-15meters  
 Controller supply voltage: DC5-24V(CV)  
 Output Current: 100W  
 Function: (Bluetooth)  
 1.Control RGB/RGBW Constant Voltage led lights.  
 2.Color changing, Dimming, changing mode, time,music.



Model: PR-BTMINI-RGB (RGB)  
 Controller supply voltage: DC5-24V(CV)  
 Output Current: 96W  
 Function: (Bluetooth)  
 1.Control RGB Constant Voltage led lights.  
 2.Color changing, Dimming, changing mode, time,music.



Model: PR-MBM-S (DIM)  
 Remote distance: 10-15meters  
 Controller supply voltage: DC5-24V(CV)  
 Output Current: 96W  
 Function: (Bluetooth)  
 1.Control Single Color Constant voltage led lights  
 2.Dimming, changing mode,time,music.  
 3.Mesh control,Maximum 64 group.



Model: PR-MBM-RGB (RGB)  
 Remote distance: 10-15meters  
 Controller supply voltage: DC12-24V(CV)  
 Output Current: 100W  
 Function: (Bluetooth)  
 1.Control RGB Constant Voltage led lights.  
 2.Color changing, Dimming, changing mode, time, music.



Model: PR-MBM-RGB (RGB)  
 Remote distance: 10-15meters  
 Controller supply voltage: DC5-24V(CV)  
 Output Current: 100W  
 Function: (Bluetooth)  
 1.Control RGB Constant Voltage led lights.  
 2.Color changing, Dimming, changing mode, time,music.  
 3.Mesh control,Maximum 64 group.



Model: PR-BLEX-IR24RGB (RGB)  
 Remote distance: 10-15meters  
 Controller supply voltage: DC5-24V(CV)  
 Output Current: 100W, **Dual Out**  
 Function: (Bluetooth)  
 1.Control RGB Constant Voltage led lights.  
 2.Color changing, Dimming, changing mode, time,music



Model: PR-MBM-RGBW (RGBW)  
 Remote distance: 10-15meters  
 Controller supply voltage: DC5-24V(CV)  
 Output Current: 100W  
 Function: (Bluetooth)  
 1.Control RGBW Constant Voltage led lights.  
 2.Color changing, Dimming, changing mode,time,music.  
 3.Mesh control,Maximum 64 group.

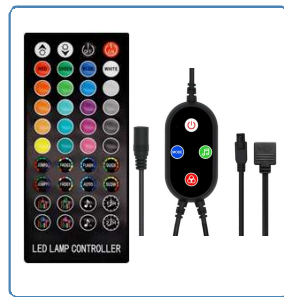

Model: PR-BLEX-IR40RGB (RGB)  
 Remote distance: 10-15meters  
 Controller supply voltage: DC5-24V(CV)  
 Output Current: 100W  
 Function: (Bluetooth)  
 1.Control RGB Constant Voltage led lights.  
 2.Color changing, Dimming, changing mode, time,music.

# Bluetooth Controller/Touch Controller

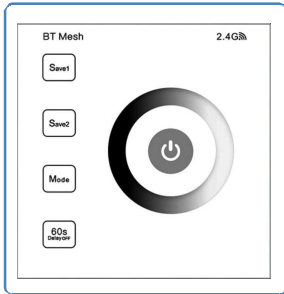

Model: PR-TCBM-S (DIM)  
 Remote distance: 10-15meters  
 Controller supply voltage: DC12-24V(CV)  
 Output Current: 96W  
 Function: (Bluetooth)  
 1.Control Single Color Constant voltage led lights  
 2.Dimming, changing mode,time,music.  
 3.Mesh control,Maximum 64 group.



Model: PR-TOUCH-MB05 (DIM)  
 Remote battery need: AAA\*3pcs  
 Remote Distance: 20-30 Meters(65-98ft)  
 Controller supply Voltage:DC12-24V(CV)  
 Output Current: 4A\*3CH(V-/V-/V-/V+)  
 Function:  
 1.Control Single Color Constant voltage led lights  
 2.Dimming,delay off.

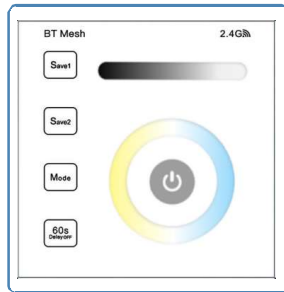

Model: OR-TCBM-CCT (CCT)  
 Remote distance: 10-15meters  
 Controller supply voltage: DC12-24V(CV)  
 Output Current: 96W  
 Function: (Bluetooth)  
 1.Control Warm+Cool white Constant Voltage led lights.  
 2.Color Temperature Changing,Dimming, changing mode,time,music.  
 3.Mesh control,Maximum 64 group.

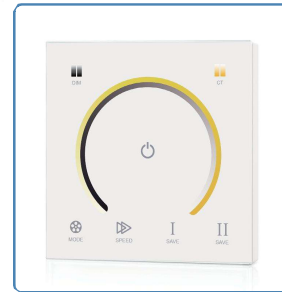

Model: PR-TOUH-MB06 (CCT)  
 Controller supply voltage: DC12-24V(CV)  
 Output Current: 4A\*2CH(C-/W-/V+)  
 Function:  
 1.Control Warm+cool white Constant Voltage led lights.  
 2.Color Temperature Changing, Dimming.

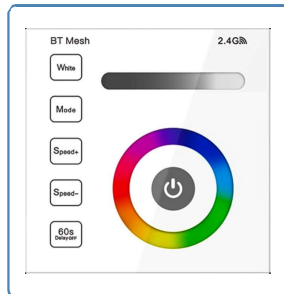

Model: PR-TCBM-RGBW (RGB/RGBW)  
 Remote distance: 10-15meters  
 Controller supply voltage: DC12-24V(CV)  
 Output Current: 100W  
 Function: (Bluetooth)  
 1.Control RGB/RGBW Constant Voltage led lights.  
 2.Color changing, Dimming, changing mode, time,music.  
 3.Mesh control,Maximum 64 group.



Model: PR-TOUCH-MB07 (RGB)  
 Controller supply voltage: DC12-24V(CV)  
 Output Current: 4A\*3CH(R-/G-/B-/V+)  
 Function:  
 1.Control R G B Constant Voltage led lights.  
 2.Color Changing, Dimming, Dynamic modes, Mix white

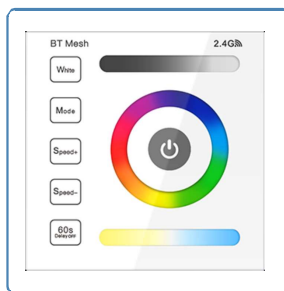

Model: PR-TCBM-RGBWC (RGBWC)  
 Remote distance: 10-15meters  
 Controller supply voltage: DC12-24V(CV)  
 Output Current: 100W  
 Function: (Bluetooth)  
 1.Control RGBWC Constant Voltage led lights.  
 2.Color changing, Dimming, changing mode,time,music.  
 3.Mesh control,Maximum 64 group.



Model: PR-TOUCH-MB08 (RGBW)  
 Controller supply Voltage:DC12-24V(CV)  
 Output Current: 4A\*4CH(R-/G-/B-/W-/V+)  
 Function:  
 1.Control R G B W Constant Voltage led lights.  
 2.Color Changing, Dimming, Dynamic modes, Pure White

# Non Smart Controller

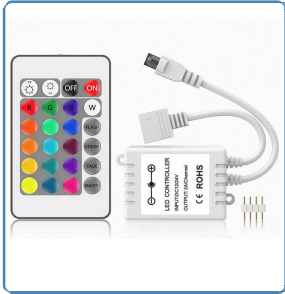

Model: PR-IR24S (RGB)  
 Remote battery need: CR2025\*1PCS  
 Remote distance: 10-15meters  
 Controller supply voltage: DC12-24V(CV)  
 Output current: 2A\*3CH  
 Function:  
 1.Control RGB Constant voltage led lights  
 2.Color Changing, Dimming



Model: PR-IR44S (RGB)  
 Remote battery need: CR2025\*1PCS  
 Remote distance: 10-15meters  
 Controller supply voltage: DC12-24V(CV)  
 Output current: 2A\*3CH  
 Function:  
 1.Control RGB Constant voltage led lights  
 2.Color Changing, Dimming



Model: PR-RFMUSIC-01 (RGB TOUCH)  
 Remote battery need: AAA\*3PCS  
 Remote distance: 20-30meters  
 Controller supply voltage: DC5-24V(CV)  
 Output current: 4A\*3CH  
 Function:  
 1.Control Single Color Constant voltage led lights  
 2.Dimming, dynamic modes.



Model: PR-RFMINI-01 (DIM)  
 Remote battery need: CR2025\*1PCS  
 Remote distance: 20-30meters  
 Controller supply voltage: DC5-24V(CV)  
 Output current: 6A\*1CH  
 Function:  
 1.Control Single Color Constant voltage led lights  
 2.Dimming, dynamic modes.



Model: PR-IRMUSIC-01 (RGB)  
 Remote battery need: CR2025\*1PCS  
 Remote distance: 20-30meters  
 Controller supply voltage: DC5-24V(CV)  
 Output current: 4A\*3CH  
 Function:  
 1.Control RGB Constant voltage led lights  
 2.Color Changing, Dimming

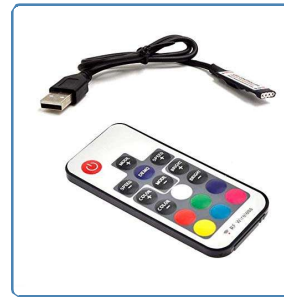

Model: PR-RFMINI-03 (RGB)  
 Remote battery need: CR2025\*1PCS  
 Remote distance: 20-30meters  
 Controller supply voltage: DC5-24V(CV)  
 Output current: 2A\*3CH  
 Function:  
 1.Control RGB Constant voltage led lights  
 2.Color Changing, Dimming



Model: PR-IRMUSIC-02 (RGB)  
 Remote battery need: CR2025\*1PCS  
 Remote distance: 20-30meters  
 Controller supply voltage: DC5-24V(CV)  
 Output current: 2A\*3CH  
 Function:  
 1.Control RGB Constant voltage led lights  
 2.Color Changing, Dimming



Model: PR-IRROPERGB (RGB)  
 Remote battery need: AA\*2PCS  
 Remote distance: 20-30meters  
 Controller supply voltage: 190-240V AC  
 Output current: 2A\*3CH (1500W)  
 Function: Waterproof IP68  
 1.Control RGB Constant voltage rope lights  
 2.Color Changing, Dimming



# Touch Controller



Model: PR-DT81 (DIM)  
 Remote battery need: AAA\*3pcs  
 Remote Distance: 20-30 Meters (65-98ft)  
 Controller supply Voltage: DC12-24V(CV)  
 Output Current: 4A\*2CH(V-/V-/V+/V+)  
 Function:  
 1. Control single color Constant Voltage led lights.  
 2. Dimming.



Model: PR-RFTC-01 (DIM)  
 Remote battery need: AAA\*3pcs  
 Remote Distance: 20-30 Meters (65-98ft)  
 Controller supply Voltage: DC12-24V(CV)  
 Output Current: 6A\*3CH(V-/V-/V+/V+)  
 Function:  
 1. Control single color Constant Voltage led lights.  
 2. Dimming.



Model: PR-SW81 (CCT)  
 Remote battery need: AAA\*3pcs  
 Remote Distance: 20-30 Meters (65-98ft)  
 Controller supply Voltage: DC12-24V(CV)  
 Output Current: 4A\*2CH(C-/C-/W-/V+)  
 Function:  
 1. Control Warm+cool white Constant Voltage led lights.  
 2. Color Temperature Changing, Dimming.



Model: PR-RFTC-02 (CCT)  
 Remote battery need: AAA\*3pcs  
 Remote Distance: 20-30 Meters (65-98ft)  
 Controller supply Voltage: DC12-24V(CV)  
 Output Current: 6A\*2CH(C-/C-/W-/V+)  
 Function:  
 1. Control Warm+cool white Constant Voltage led lights.  
 2. Color Temperature Changing, Dimming.



Model: PR-QC81 (RGB)  
 Remote battery need: AAA\*3pcs  
 Remote Distance: 20-30 Meters (65-98ft)  
 Controller supply Voltage: DC12-24V(CV)  
 Output Current: 4A\*3CH(R-/G-/B-/V+)  
 Function:  
 1. Control RGB Constant Voltage led lights.  
 2. Color Changing, Dimming, Dynamic modes.



Model: PR-RFTC-03 (RGB)  
 Remote battery need: AAA\*3pcs  
 Remote Distance: 20-30 Meters (65-98ft)  
 Controller supply Voltage: DC12-24V(CV)  
 Output Current: 6A\*3CH(R-/G-/B-/V+)  
 Function:  
 1. Control RGB Constant Voltage led lights.  
 2. Color Changing, Dimming, Dynamic modes.



Model: PR-SYNC-S01 (DIM)  
 Remote battery need: AAA\*3pcs  
 Remote Distance: 20-30 Meters (65-98ft)  
 Controller supply Voltage: DC12-24V(CV)  
 Output Current: 25A\*1CH(V-/V+)  
 Function:  
 1. Control single color Constant Voltage led lights.  
 2. Dimming.  
 3. Synchronization control.



Model: PR-SYNC-D03 (RGB)  
 Remote battery need: AAA\*3pcs  
 Remote Distance: 20-30 Meters (65-98ft)  
 Controller supply Voltage: DC12-24V(CV)  
 Output Current: 8A\*3CH(R-/G-/B-/V+)  
 Function:  
 1. Control RGB Constant Voltage led lights.  
 2. Color Changing, Dimming, Dynamic modes.  
 3. Synchronization control.





Model: PR-DL-POW1  
 DALI Bus Power Supply (DIN Rail)  
 Output : 16V  
 Max. Rated power: 4W  
 Function:  
 1. Control RGB Constant Voltage led lights.  
 2. Transmit DMX Signal to PWM.  
 3. Dip Switch / RJ45&XLR Connector



Model: PR-DL-DP1S (Single Color)  
 Supports DALI Bus power supply  
 Function:  
 1. Dimming Control of Strip Led lights.  
 2. X86 size required 2M box .  
 3. Touch Sensitive



Model: PR-DL-5in1 Controller (DL-X)  
 Controller supply Voltage: DC12-24V(CV)  
 Output Current: 6A/Ch,  
 20A Max (Multi Function)  
 Function:  
 1. 5 in 1 single color / CCT / RGB / RGBW  
 / RGB+CCT DALI protocol  
 2. Push Button support for ON/OFF,  
 Dimming



Model: PR-DL-DP2S (Dual Color)  
 Supports DALI Bus power supply  
 Function:  
 1. Dimming Control of Strip Led lights.  
 2. CCT Temp Control of Strip Lights  
 3. X86 size required 2M box .  
 4. Touch Sensitive

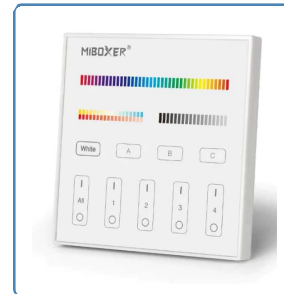

Model: PR-DL-DP3S (3in1 Touch panel)  
 Supports DALI Bus power supply  
 Function:  
 1. Dimming Control of Strip Led lights.  
 2. CCT Temp Control of Strip Lights  
 3. RGB/RGBW/RGBCW supports  
 4. X86 size required 2M box .  
 5. Touch Sensitive

# LED Dimmer



Model: PR-T4 (DIM)  
 Controller supply voltage: DC12-24V(CV)  
 Output current: 30A\*1CH  
 Function:  
 1.Control Single Color Constant voltage led lights  
 2.Dimming



Model: PR-T3 (DIM)  
 Remote battery need: CR2025\*1PCS  
 Remote distance: 10-15meters  
 Controller supply voltage: DC12-24V(CV)  
 Output current: 16A\*1CH  
 Function: PWM Dimmer  
 1.Control Single Color Constant voltage led lights  
 2.Dimming



Model: PR-RF-T2 (DIM)  
 Remote battery need: CR2025\*1PCS  
 Remote distance: 20-30meters  
 Controller supply voltage: DC12-24V(CV)  
 Output current: 30A\*1CH  
 Function:  
 1.Control Single Color Constant voltage led lights  
 2.Dimming



Model: PR-TOUCH (DIM)  
 Remote distance: 20-30meters  
 Controller supply voltage: DC12-24V(CV)  
 Output current: 8A\*1CH  
 Function:  
 1.Control Single Color Constant voltage led lights  
 2.Dimming



Model: PR-T1 (DIM)  
 Controller supply voltage: DC12-24V(CV)  
 Output current: 8A\*1CH  
 Function:  
 1.Control Single Color Constant voltage led lights  
 2. Dimming by rotating knob



Model: PR-DT22 (DIM)  
 Remote battery need: CR2025\*1PCS  
 Remote distance: 20-30meters  
 Controller supply voltage: DC12-24V(CV)  
 Output current: 8A\*1CH  
 Function:  
 1.Control Single Color Constant voltage led lights  
 2.Dimming, delay off.



Model: PR-T2 (DIM)  
 Controller supply voltage: DC12-24V(CV)  
 Output current: 6A\*1CH  
 Function:  
 1.Control Single Color Constant voltage led lights  
 2.Dimming by rotating knob  
 3. 55x21 Female IN and 55x21 Male out



Model: PR-DT23 (DIM)  
 Remote battery need: CR2025\*1PCS  
 Remote distance: 20-30meters  
 Controller supply voltage: DC12-24V(CV)  
 Output current: 6A\*3CH  
 Function:  
 1.Control Single Color Constant voltage led lights  
 2.Dimming, delay off.



# PIR SENSOR



Model: PR-LP-2016A  
 IR Sensor Switch  
 Input Voltage: DC12/24V  
 Output Current: <2A  
 Sensor distance: 3M  
 Size:φ27mm  
 N.W:22g



Model: PR-BOX8A  
 Supply voltage: DC5V,DC12V-24V  
 Size: 89\*59\*35 mm  
 Net weight: 80g  
 Induction distance:5-8m  
 Induction Angle: 120°C  
 Output current : <8A  
 Output power: 5V<40 W, 12V< 96W, 24V<192 W



Model: PR-EL-8025  
 IR Sensor Switch  
 Input Voltage: DC5-24V  
 Output Current: <3A  
 Sensor distance: 3-5M  
 Size:φ41mm  
 N.W:15g



Model: PR-RECESSPIR-200  
 Detecting Angle: 120 degree  
 Detecting Dist.: 1-8 Meter  
 Input Voltage: 220V  
 Max Load: 200W Resistive  
 Delay time: 1-10min (adjust)  
 Dimensions: Ø86mm xH36mm  
 Installation method: Recess Mount



Model: PR-LP-8025  
 IR Sensor Switch  
 Input Voltage: DC5-24V  
 Output Current: <4A  
 Sensor distance: 3-5M  
 Size:φ41mm  
 N.W:15g



Model: PR-RADAR-200  
 Detecting Angle: 120 degree  
 Detecting Dist.: 8 Meter max  
 Input Voltage: 220V  
 Max Load: 200W Max (Resistive Load)  
 Delay time: 5s-15m  
 Dimensions: Ø95mm xH26mm  
 Installation method: Surface Mount (Ceiling)



Model: PR-BOX8A  
 Supply voltage: DC5V,DC12V-24V  
 Size: 76\*45\*34 mm  
 Net weight: 60g  
 Induction distance:5-8m  
 Induction Angle: 120°C  
 Output current : <6A  
 Output power: 5V<30 W, 12V< 72W



Model: PR-X86-200  
 Detecting Angle: 120 degree  
 Detecting Dist.: 8 Meter max  
 Input Voltage: 220V  
 Max Load: 200W Max (Resistive Load)  
 Delay time: 5s-15m  
 Dimensions: 86mm x86mm (Required 2M box)  
 Installation method: Surface Mount





# LED Dimmer



Model: PR-LP-9026WT  
Touch Dimming Switch (φ19mm/φ17mm)  
Input Voltage: DC12V  
Output Current: <math>4A \times 1CH</math>  
Output Cable length: 0.5m  
Input cable length: 1.5m  
N.W: 20g



Model: PR-LP-5026T  
Hand shake Dimming OFF/ON  
Size: 28\*14\*7mm  
Voltage: DC5-24V  
Output current: 5A\*1CH  
Sensor distance: 8cm



Model: PR-SW-9024  
Hand shake Dimming Switch  
Size: 42\*32\*13mm  
Voltage: DC5-24V  
Output current: 5A\*1CH  
Sensor distance: 3-8cm



Model: PR-MIRROR-T1 (DIM)  
Input voltage: DC12-24V  
Output current: 4A\*1CH  
Function: ON/OFF, Dimmer  
Mount: Paste on mirror back surface  
1. Control Single Color Constant voltage led lights  
2. Control ON/OFF by Touch  
3. Control Dimming by Touch & Hold



Model: PR-CABINERSW-01  
Input voltage: 1-220V  
Output current: 2A\*1CH  
Function: ON/OFF  
Size: 52x50x18mm  
Mount: Screw on plain surface



# PWM Amplifier



Model: PR-AMF-L (RGB)  
 Amplifier supply Voltage: DC12-24V(CV)  
 Output Current: 4A\*3CH(R-/G-/B-/V+)  
 Function:  
 1.Control RGB Constant Voltage led lights.  
 2.Amplify controller signal and power to connect leds.



Model: PR-AMF-HT (RGB)  
 Amplifier supply Voltage: DC05-24V (CV)  
 Output Current: 10A\*3CH(R-/G-/B-/V+)  
 Function:  
 1.Control RGB Constant Voltage led lights.  
 2.Amplify controller signal and power to connect leds.



Model: PR-AMF-L4 (RGBW)  
 Amplifier supply Voltage: DC12-24V(CV)  
 Output Current: 4A\*4CH(R-/G-/B-/W-/V+)  
 Function:  
 1.Control RGBW Constant Voltage led lights.  
 2.Amplify controller signal and power to connect leds.



Model: PR-AMF-T4 (RGBW)  
 Amplifier supply Voltage: DC05-24V(CV)  
 Output Current: 8A\*4CH(R-/G-/B-/W-/V+)  
 Function:  
 1.Control RGBW Constant Voltage led lights.  
 2.Amplify controller signal and power to connect leds.



Model: PR-AMF-L1 (Single Channel)  
 Amplifier Ssupply Voltage: DC05-24V(CV)  
 Output Current: 30A\*1CH (V-/V+)  
 Function: (High speed, means quality)  
 1.Control Single Color Constant Voltage led lights.  
 2.Amplify controller signal and power to connect leds.



Model: PR-MINIAMP-1 (RGB)  
 Amplifier supply Voltage: DC12-24V(CV)  
 Output Current: 3A\*3CH(R-/G-/B-/V+)  
 Function:  
 1.Control RGBW Constant Voltage led lights.  
 2.Amplify controller signal and power to connect leds.



Model: PR-MINIAMP-2 (RGBW)  
 Amplifier supply Voltage: DC12-24V(CV)  
 Output Current: 3A\*4CH(R-/G-/B-/W-/V+)  
 Function:  
 1.Control RGBW Constant Voltage led lights.  
 2.Amplify controller signal and power to connect leds.



Model: PR-MINIAMP-3 (RGBCW)  
 Amplifier supply Voltage: DC12-24V(CV)  
 Output Current: 3A\*5CH(R-/G-/B-/C-/W-/V+)  
 Function:  
 1.Control RGBW Constant Voltage led lights.  
 2.Amplify controller signal and power to connect leds.



Model: PR-AMP-L5 (RGBCW)  
 Amplifier supply Voltage: DC12-24V(CV)  
 Output Current: 3A\*5CH(R-/G-/B-/C-/W-/V+)  
 Function:  
 1.Control RGBCW Constant Voltage led lights.  
 2.Amplify controller signal and power to connect leds.



# Pixel Controller



Model: PR-YC102W-14DIY (SPI)  
 Remote battery need: CR2025\*1PCS  
 Remote distance: 20-30meters  
 Controller supply voltage: DC5-24V(CV)  
 IC Support: SM16703.UCS1903.WS2811.  
 WS2812B.WS2813. WS2818. SK6812...  
 Function:  
 1.Control Pixel Constant voltage led lights.  
 2.Color Changing, Dimming, Chasing mode.



Model: PR-MW-HC01 (IC RGB)  
 Remote: iphone,android,echo,google home,ifttt  
 Remote distance: no limits  
 Controller supply voltage: DC12-24V(CV)  
 IC support:1903/2811/2812/6812/...  
 Function: (WiFi)  
 1.Control Pixel led lights  
 2.Color changing, Dimming, changing mode, time,music.



Model: PR-YC102W-14 (SPI)  
 Remote battery need: CR2025\*1PCS  
 Remote distance: 20-30meters  
 Controller supply voltage: DC5-24V(CV)  
 IC Support:SM16703.UCS1903.WS2811.  
 WS2812B.WS2813. WS2818. SK6812...  
 Function:  
 1.Control Pixel Constant voltage led lights.  
 2.Color Changing, Dimming, Chasing mode.



Model: PR-SP105E (IC RGB/IC RGBW)  
 Remote: iphone,android,echo,google home,ifttt  
 Controller supply voltage: DC05-24V (CV)  
 IC support:1903/2811/2812/6812/...  
 Function: (WiFi)  
 1.Control Pixel led lights  
 2.Color changing, Dimming, changing mode, time,music.  
 3. Dual Output ports



Model: PR-SP106E (SPI)  
 Remote battery need: CR2025\*1PCS  
 Remote distance: 20-30meters  
 Controller supply voltage: DC5-24V(CV)  
 IC Support: SM16703.UCS1903.WS2811.  
 WS2812B.WS2813. WS2818. SK6812...  
 Function:  
 1.Control Pixel Constant voltage led lights.  
 2.Color Changing, Dimming, Chasing & Music.



Model: PR-HC008 (IC RGB)  
 Remote battery need: 12V23A\*1PCS  
 Remote distance: 20-30meters  
 Controller supply voltage: DC5-24V(CV)  
 IC Support: 1903/2811/2812/6812/16701/  
 6803/2801...  
 Function:  
 1.Control Pixel Constant voltage led lights  
 2.Color Changing, Dimming, Chasing mode.  
 3.Sync control with RJ45



Model: PR-MW-R28A4 (IC RGB)  
 Remote: iphone,android,echo, google,ifttt  
 Remote distance: no limits  
 Controller supply voltage: DC12-24V(CV)  
 IC support:1903/2811/2812/6812/...  
 Function: (WiFi)  
 1.Control Pixel led lights  
 2.Color changing, Dimming, changing mode, time,music.  
 3. Dual output ports



Model: PR-SP901E (IC RGB)  
 Controller supply voltage: DC5-24V(CV)  
 IC support:1903/2811/2812/6812/...  
 1.Control Pixel led lights.  
 2.Amplify controller signal and power to connect leds.

# Pixel Controller



Model: PR-SP105E (IC RGB/IC RGBW)  
 Remote distance: 20-30meter (by app)  
 Controller supply voltage: DC5-24V(CV)  
 IC support:1903/2811/2812/6812/...  
 Function: (Bluetooth)  
 1.Control Pixel led lights  
 2.Color changing, Dimming, changing mode, time,music.



Model: PR-SP107E (IC RGB/IC RGBW)  
 Remote distance: 20-30meter (by app)  
 Controller supply voltage: DC5-24V(CV)  
 IC support:1903/2811/2812/6812/...  
 Function: (Bluetooth), Aux Audio support, Mic  
 1.Control Pixel led lights  
 2.Color changing, Dimming, changing mode, time,music.



Model: PR-SP108E-V1 (IC RGB/IC RGBW)  
 Remote battery need: CR2025\*1PCS  
 Remote distance: 20-30meters  
 Controller supply voltage: DC5-24V(CV)  
 IC Support:SM16703.UCS1903.WS2811.  
 WS2812B.WS2813. WS2818. SK6812...  
 Function: (WiFi)  
 1.Control Pixel Constant voltage led lights.  
 2.Color Changing, Dimming, Chasing mode.



Model: PR-SP108E-V2 (IC RGB/IC RGBW)  
 Remote distance: no limits  
 Controller supply voltage: DC12-24V/5V(CV)  
 IC support:1903/2811/2812/6812/...  
 Function: (WiFi)  
 1.Control Pixel led lights  
 2.Color changing, Dimming, changing mode, time,music.



Model: PR-SP110E (IC RGB/IC RGBW)  
 Remote distance: no limits  
 Controller supply voltage: DC5-24V(CV)  
 IC Support: SM16703.UCS1903.WS2811.  
 WS2812B.WS2813. WS2818. SK6812...  
 Function: (WiFi)  
 1.Control Pixel Constant voltage led lights.  
 2.Color Changing, Dimming, Chasing mode.



Model: PR-SP501E (IC RGB)  
 Remote distance: 20-30meters  
 Controller supply voltage: DC5-24V(CV)  
 IC Support: 1903/2811/2812/6812/16701/  
 6803/2801...  
 Function:  
 1.Control Pixel Constant voltage led lights  
 2.Color Changing, Dimming, Chasing mode.  
 3. Music



Model: PR-SP601E (IC RGB), Dual Out  
 Remote battery need: CR2025\*1PCS  
 Remote distance: 20-30meters  
 Controller supply voltage: DC5-24V(CV)  
 IC Support: SM16703.UCS1903.WS2811.  
 WS2812B.WS2813. WS2818. SK6812...  
 Function: (WiFi)  
 1.Control Pixel Constant voltage led lights.  
 2.Color Changing, Dimming, Chasing mode.



Model: PR-SP608E (IC RGB), 8 Port Output  
 Remote battery need: CR2025\*1PCS  
 Remote distance: 20-30meters  
 Controller supply voltage: DC5-24V(CV)  
 IC support:1903/2811/2812/6812/...  
 1.Control Pixel led lights.  
 2.Amplify controller signal and power to connect leds.



Model: PR-SP602E (IC RGB), 4Ch Out  
 Remote battery need: CR2025\*1PCS  
 Remote distance: 20-30meters  
 Controller supply voltage: DC5-24V(CV)  
 IC Support: SM16703.UCS1903.WS2811.  
 WS2812B.WS2813. WS2818. SK6812...  
 Function: Bluetooth  
 1.Control Pixel Constant voltage led lights.  
 2.Color Changing, Dimming, Chasing mode.



Model: PR-SP611E (IC RGB),  
 Remote battery need: CR2025\*1PCS  
 Remote distance: 20-30meters  
 Controller supply voltage: DC5-24V(CV)  
 IC support:1903/2811/2812/6812/...  
 Function: Bluetooth  
 1.Control Pixel led lights.  
 2.Amplify controller signal and power to connect leds.





## Pixel Controller (SD card Version)



Model: PR-T1000S (IC RGB/IC RGBW)  
 Program by PC using LED edit ..  
 Support 32 Programs on SD card  
 Controller supply voltage: DC5-24V(CV)  
 IC support:1903/2811/2812/6812/...  
 Function: (SD card Support)  
 Pixel Qty: 512 with 30 fps  
 1. Multi Controllers can sync. (via RS485 interface)  
 2.Color changing, Dimming, changing mode



Model: PR-K1000C (IC RGB/IC RGBW)  
 Program by PC using LED edit ..  
 Support 32 Programs on SD card  
 Controller supply voltage: DC5-24V(CV)  
 IC support:1903/2811/2812/6812/...  
 Function: (SD card Support)  
 Pixel Qty: 512 with 30 fps  
 1. Multi Controllers can sync. (via RS485 interface)  
 2.Color changing, Dimming, changing mode



Model: PR-T8000AC (IC RGB/IC RGBW)  
 Program by PC using LED edit ..  
 Support 32 Programs on SD card  
 Controller supply voltage: DC5-24V(CV)  
 IC support:1903/2811/2812/6812/...  
 Function: (SD card Support)  
 Pixel Qty: 8192 (8\*1024)  
 1. Multi Controllers can sync. (via RS485 interface)  
 2.Color changing, Dimming, changing mode



Model: PR-LC1000A (IC RGB/IC RGBW)  
 Size: L85mm X W45mm X H22mm  
 Input Voltage: DC7~24V  
 Number of pixels: 8~1024 pixel  
 Speed Control: 32 adjustable  
 Memory: Automatic memory function  
 LED sequence: RGB Arbitrarily set  
 Control mode: APP  
 Music Control: MIC or Line input



LED Colorful



Model: PR-LC2000B (IC RGB/IC RGBW)  
 Size: L120mm X W65mm X H24mm  
 Input Voltage: DC7~24V  
 Number of pixels: 8~2048 pixel  
 Speed Control: 32 adjustable  
 Memory: Automatic memory function  
 LED sequence: RGB Arbitrarily set  
 Control mode: APP  
 Music Control: MIC or Line input  
**Sync Type:485 cascade control.**



LED Colorful

# Zigbee Controller



Model: PR-PR-006S CCT RF  
 Control Method: WIFI-APP (2.4Ghz)  
 Controller supply voltage: DC12-24V(CV)  
 Function: (Zigbee 3.0)  
 1.Control Dual Color Light strips  
 2. Can be paired with RF Touch Panel Remote  
 3.Color changing, Dimming, changing mode, time,music.



Model: PR-PR-007S RGBW RF  
 Control Method: WIFI-APP (2.4Ghz)  
 Controller supply voltage: DC12-24V(CV)  
 Function: (Zigbee 3.0)  
 1.Control Dual Color Light strips  
 2. Can be paired with RF Touch Panel Remote  
 3.Color changing, Dimming, changing mode, time, music.



Model: PR-008S RGB CCT RF  
 Control Method: WIFI-APP (2.4Ghz)  
 Controller supply voltage: DC12-24V(CV)  
 Function: (Zigbee 3.0)  
 1.Control Dual Color Light strips  
 2. Can be paired with RF Touch Panel Remote  
 3.Color changing, Dimming, changing mode, time, music.



Model: PR-008 RGB CCT 2ID  
 Control Method: WIFI-APP (2.4Ghz)  
 Controller supply voltage: DC12-24V(CV)  
 Function: (Zigbee 3.0)  
 1.Control Dual Color Light strips  
 2. Device broadcast two SSID RGB+CCT  
 3.Color changing, Dimming, changing mode, time, music.



Model: PR-RF 2.4GHZ BRIDGE  
 Control Method: WIFI-APP (2.4Ghz)  
 Controller supply voltage: DC05V USB  
 Function: (Zigbee 3.0)  
 1.Control Dual Color Light strips  
 2.Can Convert RF 2.4Ghz Controllers to Zigbee



Model: HUE ZIGBEE BRIDGE 3.0  
 Remote distance: no limits  
 Function:  
 1. Control all above controllers via Hue App  
 2.Color Changing, Dimming, Chasing mode.  
 3. Timing  
 4. Music via third party apps

## Compatible Hub for Zigbee Controllers



HUE 3.0



ECHO PLUS



LIGHTIFY



SMARTTHINGS



## Accessories



Model: PR-RGBSPLIT-2 (RGB)  
 Max Input Load: 3A\*3CH(R-/G-/B-/V+)  
 Function:  
 1. Split RGB signal into two ports.  
 2. Application for RGB Amplifier input and Multi output.



Model: PR-RGBWSPLIT-2 (RGBW)  
 Max Load: 3A\*4CH(R-/G-/B-/W-/V+)  
 Function:  
 1. Split RGBW signal into two ports.  
 2. Application for RGBW Amplifier input and Multi output.



Model: PR-RGBSPLIT-4 (RGBW)  
 Max Load: 3A\*3CH(R-/G-/B-/V+)  
 Function:  
 1. Split RGB signal into Four ports.  
 2. Application for RGB Amplifier input and Multi output.

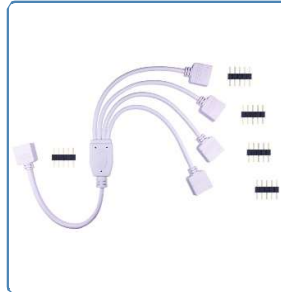

Model: PR-RGBWSPLIT-4 (RGBW)  
 Max Load: 3A\*4CH(R-/G-/B-/W-/V+)  
 Function:  
 1. Split RGBW signal into Four ports.  
 2. Application for RGBW Amplifier input and Multi output.



Model: PR-CS3P-3 (3 Pin)  
 3 Pin Solder less connector  
 PCB Width : 10mm  
 Max Current: 3A\*3CH (+/D/-)



Model: PR-CL3P-3 (3 Pin)  
 3 Pin Solder less bend connector  
 PCB Width : 10mm  
 Max Current: 3A\*3CH (+/D/-)



Model: PR-CS4P-4 (4 Pin)  
 4 Pin Solder less connector  
 PCB Width : 10mm  
 Max Current: 3A\*4CH(R-/G-/B-/V+)



Model: PR-CL4P-4 (4 Pin)  
 4 Pin Solder less L bend connector  
 PCB Width : 10mm  
 Max Current: 3A\*4CH(R-/G-/B-/V+)



Model: PR-CS5P-5 (5 Pin)  
 5 Pin Solder less connector  
 PCB Width : 10-12mm  
 Max Current: 3A\*5CH(R-/G-/B-/W-/V+)

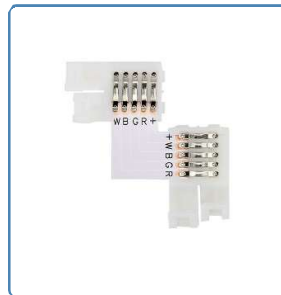

Model: PR-CL5P-5 (5 Pin)  
 5 Pin Solder less L bend connector  
 PCB Width : 10-12mm  
 Max Current: 3A\*5CH(R-/G-/B-/W-/V+)

## Accessories

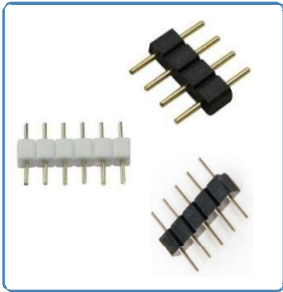

Model: PR-CPIN-4 (RGB)  
Model: PR-CPIN-5 (RGBW)  
Model: PR-CPIN-6 (RGBCW)

Support Strip Voltage: DC12-24V (CV)  
Max Current: 4A/Ch  
Function:  
1. Join Strip to Strip.  
2. Convert Female to male



Model: PR-CW3P-15 (3 Pin)

Max Current: 3A\*3CH  
Wire AWG #22 (1 Sq mm)  
Wire Length: 15cm



Model: PR-CS5521-M  
Model: PR-CS5521-F

Can Handle supply Voltage: DC12-24V  
Max Current: 6A  
Function: Screw Lock  
1. Power input to DC strip.  
2. Power input to amplifier  
3. Power input to Controller



Model: PR-CW4P-15 (4 Pin)

Max Current: 3A\*4CH  
Wire AWG #22 (1 Sq mm)  
Wire Length: 15cm  
Output : R-/G-/B-/V+



Model: PR-CP5521-M  
Model: PR-CP5521-F

Can Handle supply Voltage: DC12-24V  
Max Current: 8A  
Function: Press and Lock  
1. Power input to DC strip.  
2. Power input to amplifier  
3. Power input to Controller

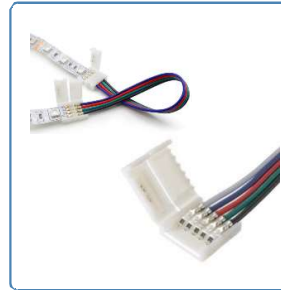

Model: PR-CW5P-15 (5 Pin)

Max Current: 3A\*5CH  
Wire AWG #22 (1 Sq mm)  
Wire Length: 15cm  
Output : R-/G-/B-/V+



Model: PR-CWJST3-15 (3 Pin)

Max Current: 3A\*3CH  
Wire AWG #22 (1 Sq mm)  
Wire Length: 15cm



Model: PR-CSIP674P-4P

Max Voltage: DC12-24V(CV)  
Max Current: 5A\*4CH (R-/G-/B-/V+)  
Function:  
1. 20 - 18 AWG Wire No Stripping  
2. 4pin 10mm LED strip



Model: PR-CWJST3-40 (3 Pin)

Max Current: 3A\*3CH  
Wire AWG #22 (1 Sq mm)  
Wire Length: 40cm



Model: PR-CSIP675P-5P

Max Voltage: DC12-24V(CV)  
Max Current: 5A\*5CH (R-/G-/B-/W-/V+)  
Function:  
1. 20 - 18 AWG Wire No Stripping  
2. 5pin 12mm LED strip

# WIRES/CABLES



Model: PR-CSW4P-15 (4 Pin)

Max Current: 3A\*4CH  
Wire AWG #22 (1 Sq mm)  
Wire Length: 15cm  
Output : R-/G-/B-/V+

Connector Strip to controller



Model: PR-PCORD2C1438 (2 Core)

Wire AWG #24 (0.5 Sq mm)  
Bundle Length : 90 Meter  
2 Core PVC insulated (85°C)  
Max Current: 6A



Model: PR-EW4P-100 (4 Pin)

Max Current: 3A\*4CH  
Wire AWG #22 (1 Sq mm)  
Wire Length: 100cm  
Input/Output : R-/G-/B-/V+



Model: PR-W2C1438-2 (2 Core)

Wire AWG #18 (0.85 Sq mm)  
Bundle Length : 90 Meter  
2 Core Ribbon PVC (105°C)  
Max Current: 6A

This 18 AWG Stranded Electrical Wire are consist of 38 tiny lines which twined together, the cross-sectional area is 0.85mm<sup>2</sup>.



Model: PR-EW5P-100 (5 Pin)

Max Current: 3A\*5CH  
Wire AWG #22 (1 Sq mm)  
Wire Length: 100cm  
Input/Output : R-/G-/B-/W-/V+



Model: PR-W3C1438-3 (3 Core)

Wire AWG #18 (0.85 Sq mm)  
Bundle Length : 90 Meter  
3 Core Ribbon PVC (105°C)  
Max Current: 6A

This 18 AWG Stranded Electrical Wire are consist of 38 tiny lines which twined together, the cross-sectional area is 0.85mm<sup>2</sup>.



Model: PR-CLIP-8  
Model: PR-CLIP-10  
Model: PR-CLIP-12

Material: PVC  
Fixing Method: Screw  
Hold 8-12mm Light strip on surface



Model: PR-W4C1438-4 (4 Core)

Wire AWG #18 (0.85 Sq mm)  
Bundle Length : 90 Meter  
3 Core Ribbon PVC (105°C)  
Max Current: 6A

This 18 AWG Stranded Electrical Wire are consist of 38 tiny lines which twined together, the cross-sectional area is 0.85mm<sup>2</sup>.



Model: PR-DPTAPE-8  
Model: PR-DPTAPE-10  
Model: PR-DPTAPE-12

High Bond transparent double sided polyester tape used for sticking LED strips on plain surface.



Model: PR-W5C1438-5 (5 Core)

Wire AWG #18 (0.85 Sq mm)  
Bundle Length : 90 Meter  
3 Core Ribbon PVC (105°C)  
Max Current: 6A

This 18 AWG Stranded Electrical Wire are consist of 38 tiny lines which twined together, the cross-sectional area is 0.85mm<sup>2</sup>.



## POWER SUPPLIES (Constant Voltage 5V Version)



**Model: Adapter**

Input Voltage: 190-240V AC  
Working Temp: -20°C~+60°C  
Working Humidity: 20%~90%RH

**Safety :**

Withstand Voltage  
I/P-O/P: 1.5KVAC/1min; I/P-F/G:  
1.5KVAC/1min; O/P-F/G: 0.5KVAC/1min;

**Features:**

- Automatic overload cut-off, over Voltage cut-off, automatic thermal cut-off, short circuit



**Model: Slim form factor (35mm)**

Input Voltage: 190-240V AC  
Working Temp: -20°C~+60°C  
Working Humidity: 20%~90%RH

**Safety :**

Withstand Voltage  
I/P-O/P: 1.5KVAC/1min; I/P-F/G:  
1.5KVAC/1min; O/P-F/G: 0.5KVAC/1min;

**Features:**

- Automatic overload cut-off, over Voltage cut-off, automatic thermal cut-off, short circuit



**Model: Rainproof**

Input Voltage: 190-240V AC  
Working Temp: -20°C~+60°C  
Working Humidity: 20%~90%RH

**Safety :**

Withstand Voltage  
I/P-O/P: 1.5KVAC/1min; I/P-F/G:  
1.5KVAC/1min; O/P-F/G: 0.5KVAC/1min;

**Features:**

- Automatic overload cut-off, over Voltage cut-off, automatic thermal cut-off, short circuit



**Model: Slim form factor (35mm)**

Input Voltage: 190-240V AC  
Working Temp: -20°C~+60°C  
Working Humidity: 20%~90%RH

**Safety :**

Withstand Voltage  
I/P-O/P: 1.5KVAC/1min; I/P-F/G:  
1.5KVAC/1min; O/P-F/G: 0.5KVAC/1min;

**Features:**

- Automatic overload cut-off, over Voltage cut-off, automatic thermal cut-off, short circuit

## SPECIFICATIONS (Output: 5 Volt ±5%)

Form	Adapter	Slim		Rainproof			
ASIN	B08DC9JM1X	B08M49CV82	B08M4BHF9Y	B08M471LBN	B08J4DG222	B08J4F77WX	NEW
SKU	AWH7SGBNA1 PR05-050	679360649251	679360750445	679360604021	AWV8VZTNA2	AWV8VZTNA1	AWV8VZTNA2
Output Power (Max) W	25W	200W	300W	200W	300W	350W	400W
Output Current (Max) A	5	40	60	40	60	70	80
Outer Material	Plastic	Metal	Metal/Fan	Metal	Metal	Metal	Metal
Efficiency (%)	80	88	88	80	80	80	80
Dimensions L x W x H (mm)	130 x 65 x 35	200 x 90 x 35	200 x 90 x 35	190 x 100 x 60	220 x 110 x 60	220 x 110 x 60	230 x 130 x 70
Weight (gm)	200	390	470	470	690	715	820

# POWER SUPPLIES (Constant Voltage 12V Version)



**Model: Adapter**

Input Voltage: 190-240V AC  
 Working Temp: -20°C~+60°C  
 Working Humidity: 20%~90%RH

**Safety :**

Withstand Voltage  
 I/P-O/P: 1.5KVAC/1min; I/P-F/G: 1.5KVAC/1min; O/P-F/G: 0.5KVAC/1min;

**Features:**

- Automatic overload cut-off, over Voltage cut-off, automatic thermal cut-off, short circuit Protection



**Model: Ultra Slim form factor (24mm)**

Input Voltage: 190-240V AC  
 Working Temp: -20°C~+60°C  
 Working Humidity: 20%~90%RH

**Safety :**

Withstand Voltage  
 I/P-O/P: 1.5KVAC/1min; I/P-F/G: 1.5KVAC/1min; O/P-F/G: 0.5KVAC/1min;

**Features:**

- Automatic overload cut-off, over Voltage cut-off, automatic thermal cut-off, short circuit Protection

## SPECIFICATIONS (Output: 12 Volt ±5%)

Form	Adapter	Ultra Slim (24mm)			
ASIN	B07VH5YDPJ	B08J4BLT88	B08J4C8X25	B08J4D5BP7	B08L5FZY57
SKU	AW07TGBNA1 PR12-050	AWV8VSTNA1	AWV8WSTNA1	AWV8XSTNA1	679360632437
Output Power (Max) W	60W	100W	200W	300W	400W
Output Current (Max) A	5	8.3	16.6	25	33.3
Outer Material	Plastic	Metal	Metal	Metal/Fan	Metal/Dual Fan
Efficiency (%)	80	85	85	85	85
Dimensions L x W x H (mm)	130 x 65 x 35	190 x 60 x 24	310 x 60 x 24	310 x 60 x 24	400 x 60 x 24
Weight (gm)	250	190	350	355	450

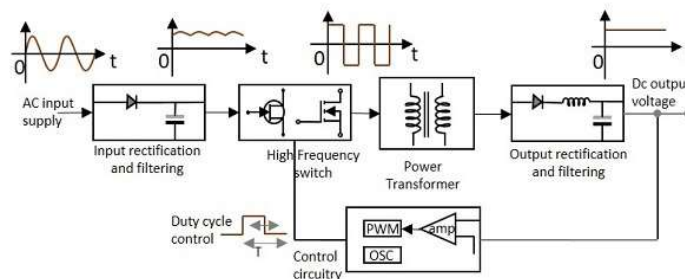

Functional block diagram of SMPS

# POWER SUPPLIES (Constant Voltage 12V Version)



**Model: Rainproof**

Input Voltage: 190-240V AC  
 Working Temp: -20°C~+60°C  
 Working Humidity: 20%~90%RH

**Safety :**

Withstand Voltage  
 I/P-O/P: 1.5KVAC/1min; I/P-F/G:  
 1.5KVAC/1min; O/P-F/G: 0.5KVAC/1min;

**Features:**

- Automatic overload cut-off, over Voltage cut-off, automatic thermal cut-off, short circuit



## SPECIFICATIONS (Output: 12 Volt ±5%)

Form	Rainproof					
ASIN	B08J4BPNMN	B08J4C1G5R	B08J3GKSLR	B08L5GB1DC	B093L1FRNT	B093KZJFLS
SKU	AWV8VGTNA1	AWV8WGTNA1	AWV8XGTNA1	679360720127	679360615775	679360664766
Output Power (Max) W	100W	200W	250W	400W	600W	700W
Output Current (Max) A	8.3	16.6	20.8	33.3	50	58.33
Outer Material	Metal	Metal	Metal	Metal	Metal	Metal
Efficiency (%)	80	80	80	80	80	80
Dimensions L x W x H (mm)	140 x 80 x 50	150 x 100 x 60	160 x 100 x 60	216 x 120 x 56	227 x 120 x 56	240 x 120 x 56
Weight (gm)	232	370	422	512	890	925

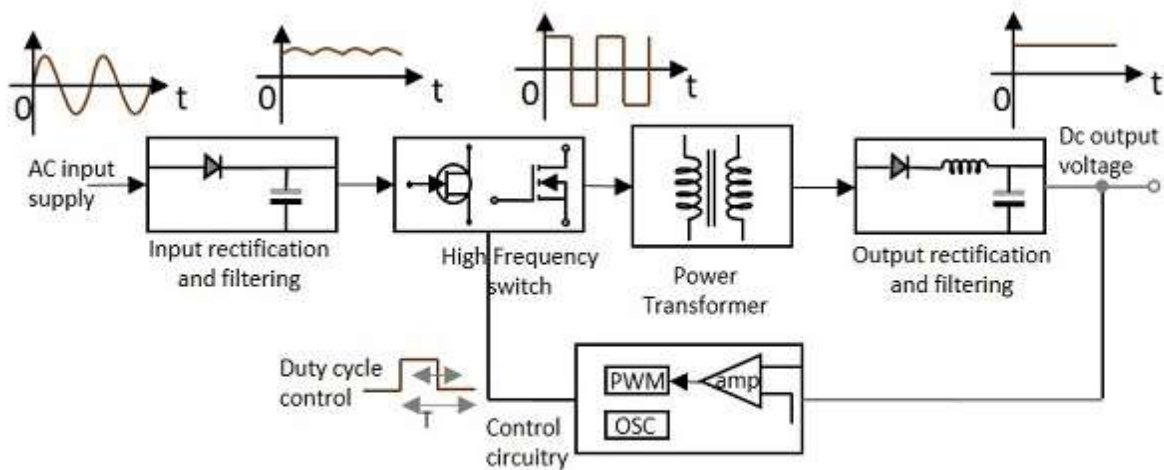

Functional block diagram of SMPS

# DIMMABLE POWER SUPPLIES (Dimmable Version)



**Model: Dimmable Power Supply**

Input AC Voltage: 190-240V AC  
 Working temperature 90°C @12V  
 Working Humidity: 20%~90%RH  
 Compatible with 0-10V, 1-10V dimmer, TRIAC dimmer & DALI control system;

**Safety :**

Withstand Voltage  
 I/P-O/P: 1.5KVAC/1min; I/P-F/G: 1.5KVAC/1min; O/P-F/G: 0.5KVAC/1min;

**Features:**

- Automatic overload cut-off, over Voltage cut-off, automatic thermal cut-off, short circuit protection
- Fan less design, long life, cost-efficiency;

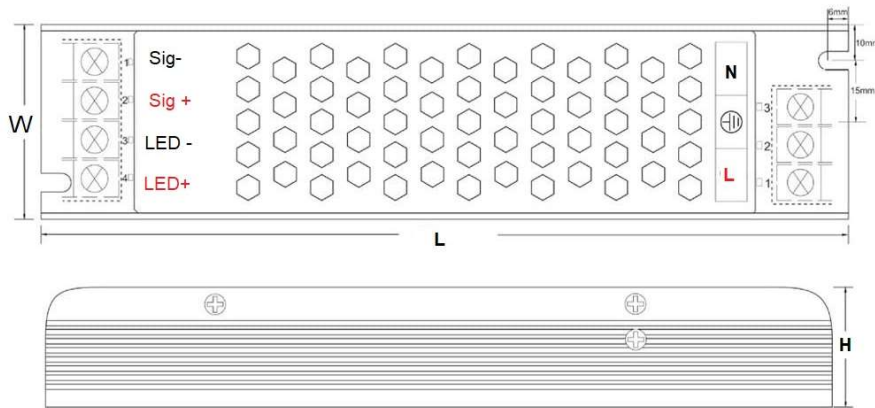

## SPECIFICATIONS (Output: 12 Volt ±5%)

Form	Dimmable Power Supply		
ASIN	B08WWT9GG1	B08WWWGWRZ	B08WX4HSC
SKU	PR-12VDIMM-60	PR-12VDIMM-150	PR-12VDIMM-200
Output Voltage (V)	12V	12V	12V
Output Power (Max) W	60W	150W	200W
Output Current (Max) A	5	12.5	16.6
Outer Material	Metal	Metal	Metal
Efficiency (%)	> 86	> 86	> 86
Dimensions (L x W x H mm)	185 x 50 x 29	285 x 50 x 29	285 x 50 x 29
Weight (gm)	215	370	425



[www.protiumonline.com](http://www.protiumonline.com)



[automation@protiumonline.com](mailto:automation@protiumonline.com)



PROTIUM LED CONTROLLER VER 4.2